

Standard enclosure
Series CPG

Designation CPG-300	Article number 430000000
----------------------------	---------------------------------

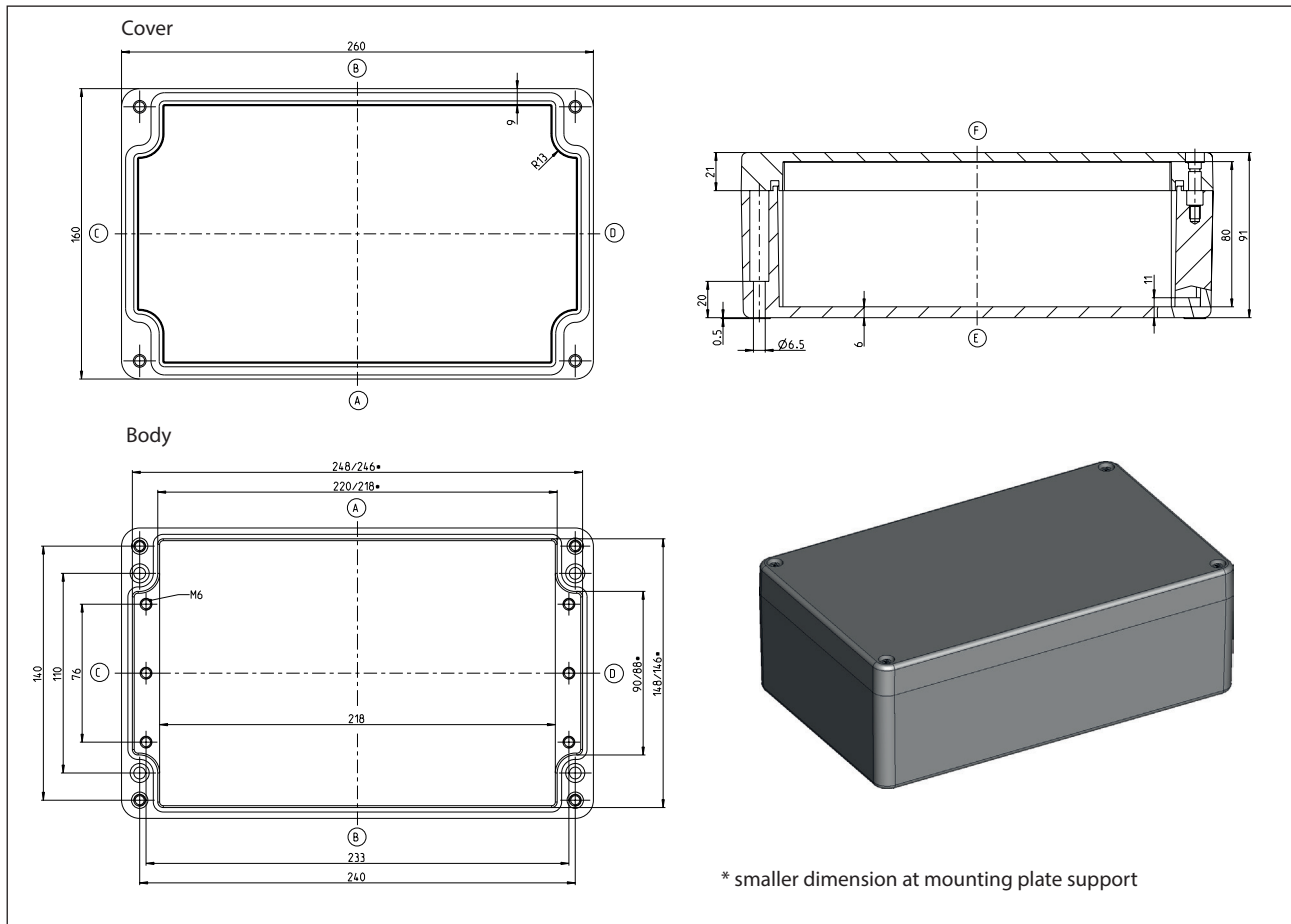

Standard version
Scope of supply:
Base of enclosure
Enclosure cover
Cover screws (cross recessed head) enclosed loosely
Colour RAL 7000 (squirrel grey)
Cover gasket PUR (polyurethane)
Individually packaged in foil

Maximum possible number of thread (figures for identical diameter, not mixed!)								
ISO M	M12	M16	M20	M25	M32	M40	M50	M63
Page A/B	33	15	12	8	4	3	3	0
Page C/D	9	4	3	2	2	1	0	0

Property chart CPG-300

Specification	Value	According to the standard	Remark
General data:			
Weight	1710 g		
External dimensions	260 x 160 x 91		
Protection classes			
IP-code	IP 66	EN 60529	
IP-code	IP67	EN 60529	
IK- code	IK08	IEC 62262	
Material			
Enclosure	Polyester SMC 0190		squirrel grey
Screws	A2-70	DIN EN ISO 3506-1	Cover screws
Spring washer	1.4310	DIN EN 10088-3	
Insert nuts	1.4305 CuZn39Pb3-M	DIN EN 10088-3	
Gasket	PUR (Polyurethan)		Colour: dark grey, 2-component polyurethane foam seal
Toxic behaviour	halogen-free		
Thermal properties:			
Fire behaviour			
Flammability	V-0	UL 94	Contentwise alike with EC60695-11-10 and IEC60695-11-20
Glow wire test	960 °C	IEC 60707-3	
Glow wire test			
Glow wire test			
Temperature range			
Enclosure without a seal	-60 °C bis +165 °C		
PUR-seal	-40 °C bis +100 °C		
Temperature index Enclosure material			
RTI (tensile strength)	130 °C	UL 746 B	
RTI (impact strength)	130 °C	UL 746 B	
RTI (dielectric strength)	105 °C	UL 746 B	
Ambient temperature according to DIN EN 62208			
Indoor application	-5 °C bis +40 °C	DIN EN 62208	On the average over 24h +35°C
Relative humidity according to DIN EN 62208			
Indoor application	max. 50% bei -40 °C	DIN EN 62208	with low temperatures also higher (for ex. 90% at +20°C)
Storage temperature	-20 °C bis +60 °C		
Enclosure-specific thermal conductivity value	1,72 K/W		taking account of effective dissipation loss

Property chart CPG-300

Specification	Value	According to the standard	Remark
Mechanical properties:			
Torques			
Cover screws	2,0 Nm		
Attachment of accessories	2,0 Nm		for ex. mounting plates, mounting rails
Other mounting	2,0 Nm		Screw channel, External mounting brackets
Maximum installation weight	2,6 kg		
Electrical characteristics:			
Protection class	II	EN 61140 / VDE 0140-1	 Protection by double or reinforced insulation
Rated voltage	max. 750 V		Maximum length of the extension arm
Surface resistivity	10 ¹² Ohm	IEC 60093	
dielectric strength	18 kv/mm	IEC 60243-1	
More details:			
General tolerance	mH	ISO 2768	
Product standard	Yes	DIN EN 62208	Empty enclosures for low-voltage switchgear assemblies
Approvals			
c UL us	Yes	UL508A / C22,2	Type 1, 4, 4x
Compliances			
RoHs	Yes	Directive 2011/65 /EU	
CE label	Yes	EC-No 765/2008	
Low-Voltage-Directive No.:	2014/35/EU		

Other versions / Accessories

The following information is not a standard. Approvals, compliances and protection classes of these versions upon request.

Other versions CPG-300	
Description of the modification compared with the standard version	Article number
RAL 7000 (squirrel grey), with PUR seal and Socket head cap screws	upon request
RAL 7000 (squirrel grey), with PUR seal and Socket head cap screws	4300014000

accessoires possibles/ as individual parts or as assembly set	
Description of the modification compared with the standard version	Article number
Mounting plate	9823007000
Mounting rail TS 15	-
Mounting rail TS 32	9821008000
Mounting rail TS 35	9822011000
Earthing rail (secured on central bosses C/D)	9810010000
External mounting brackets	9824004000
External articulated hinges for Enclosure CPG (mechanical machining of the enclosure required)	9801045000
Internal articulated hinges with cover guide (mechanical machining of the enclosure required)	9801032000

optional seals			
Specification	Value	According to the standard	Remark
Thermal properties:			
CR gasket	-30 °C bis +80 °C		IP66
Silicone foam seal	-60 °C bis +130 °C		IP66 / IP67
Silicone complete seal	-60 °C bis +200 °C		IP66 / IP67
EPDM seal	-35 °C bis +100 °C		IP66
HF seal	-55 °C bis +125 °C		upon request